

# DETALLES ARQUITECTÓNICOS

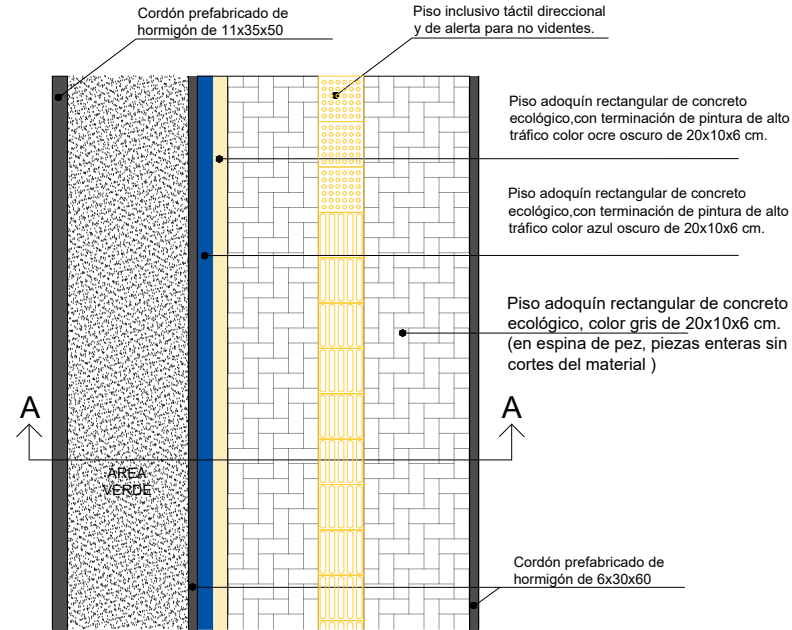

DETALLE PISO DE VEREDA ESC.....1/50

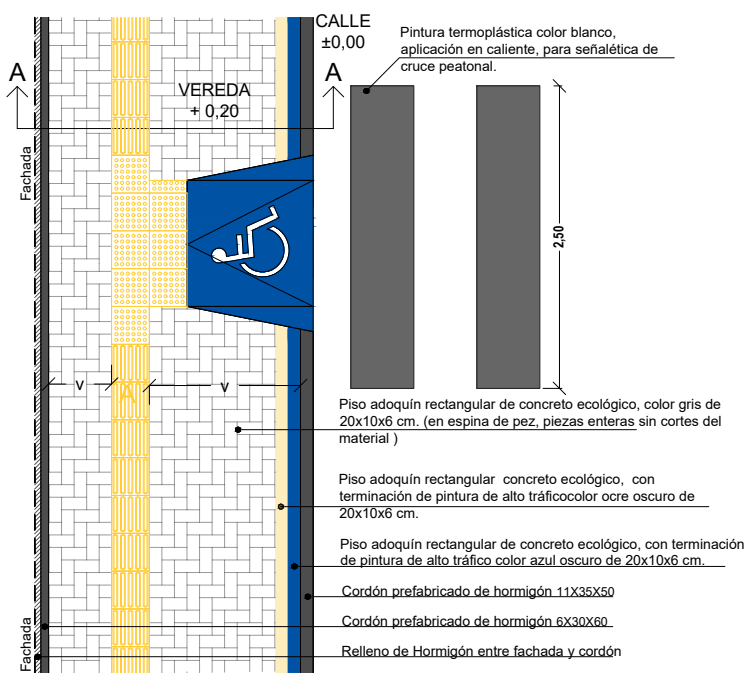
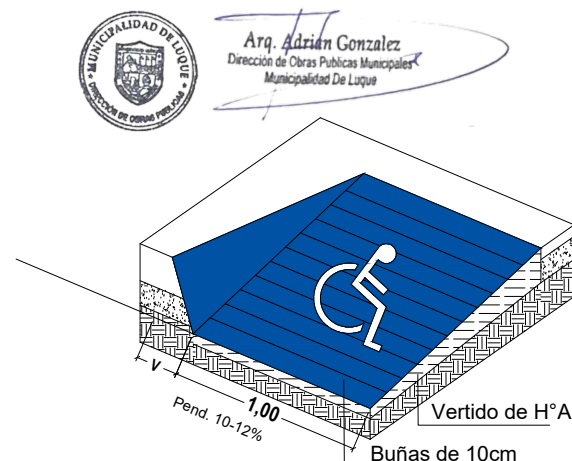
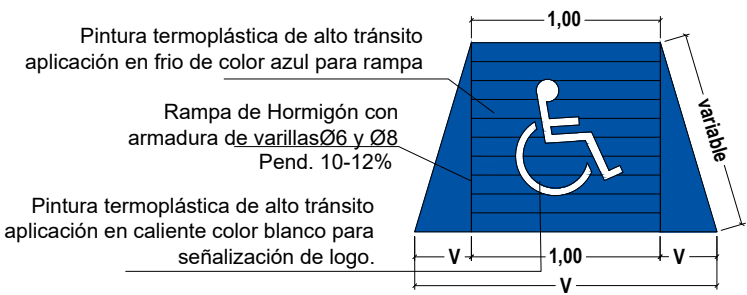
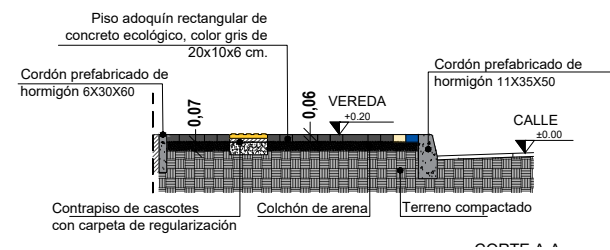
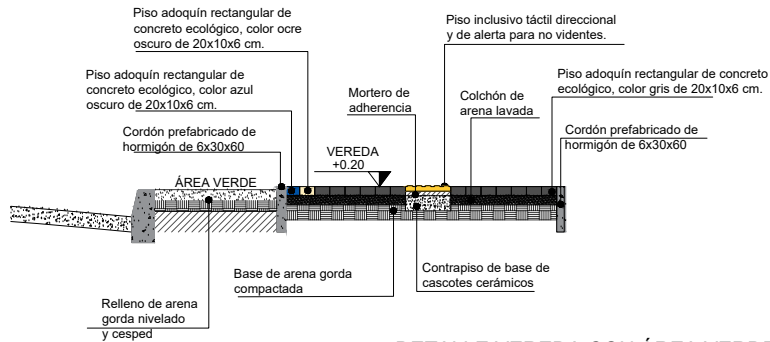
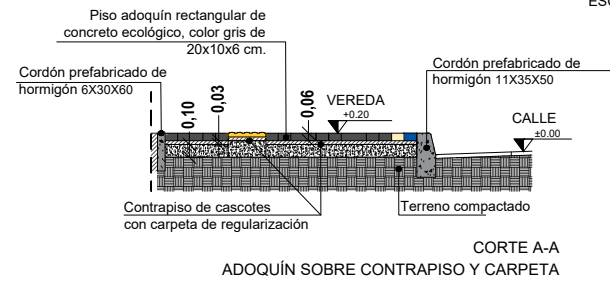

DETALLE RAMPA PEATONAL ESC.....1/50

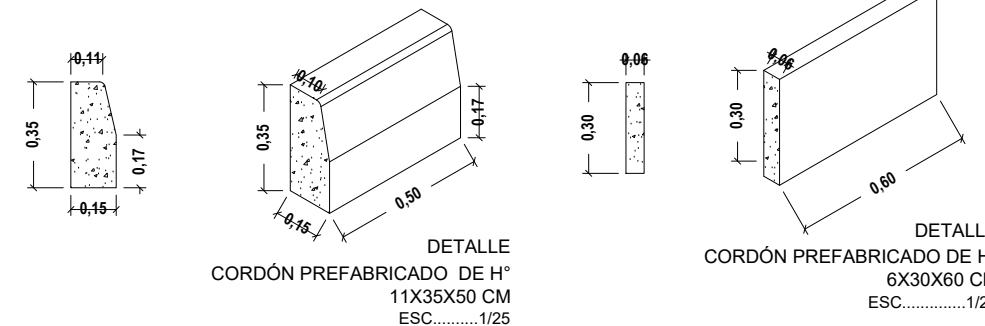
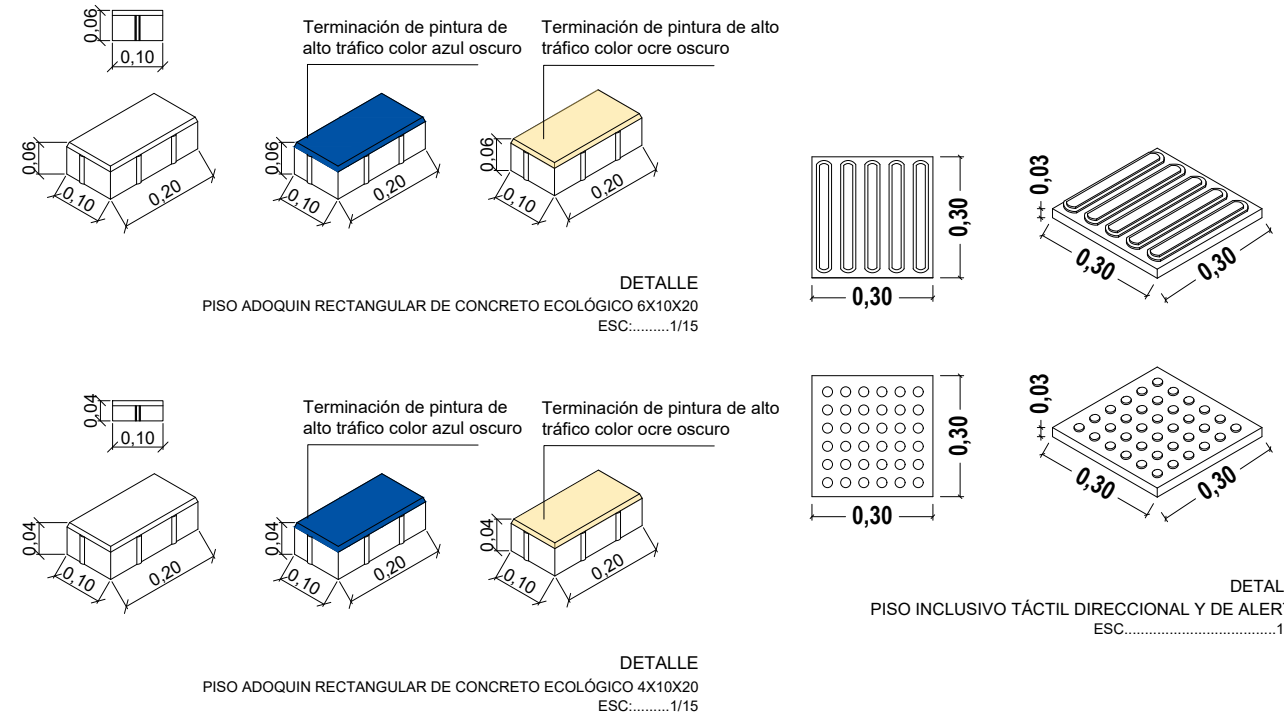

<b>PROYECTO</b> UNIFICACIÓN DE VEREDAS, TRAMO 6	
UBICACIÓN:	
PROPIETARIO:	
DOMICILIO:	
PROFESIONAL:	PATENTE N°:
DOMICILIO:	
SUPERFICIE DEL TERRENO:	
SUPERFICIE A CONSTRUIR:	
CTA. CTE. CTRL.:	
.....	.....
PROPIETARIO	PROFESIONAL
LÁMINA	
7	